

GA Panel-Fix: Wall Panel Fixing System

Just enough slip and a very good grip

Fitting and hanging wall panels couldn't be easier than with GA's 'invisible' panel fixing system. GA Panel-Fix has a number of advantages over conventional split batten systems and incorporates the following features and benefits:

- **Rigid interlocking grip** – avoiding the 'popping-off' problem associated with other split batten systems
- **Lateral adjustment** – allows for sideways movement
- **Extruded aluminium alloy** – tough and resilient
- **'Invisible'** – the profiles are concealed by the secured panel
- **Rapid installation** – facilitated by the pre-drilled csk holes (@ 200mm centres)
- **Economic** – Profile GA WP1 and alternative super light-weight GA WP2 available

Product illustrations GA WP1/2 are shown at actual size
Specification 6063 T5
Available from stock mill finish
When ordering please quote the GA code
Samples will be sent on request



GA Panel-fix wall panel fixing system

Order code	Wall to panel fixing distance mm	Material thickness mm
GA WP1	8.7	2.0
GA WP2	5.2	1.2

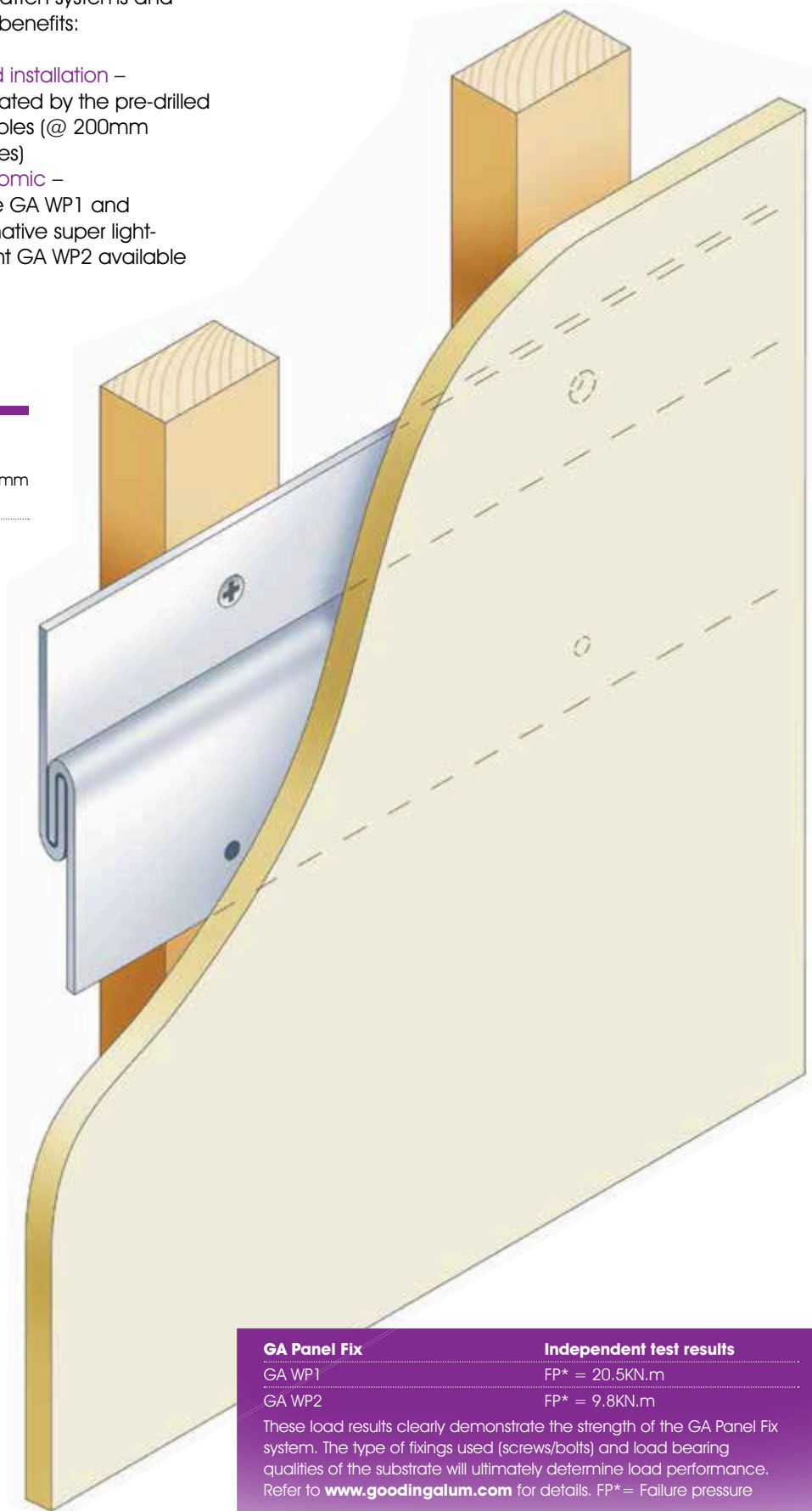

“ Thanks for the prompt delivery of my order. I won't hesitate to use your products in the future ”

Graham Lomas,
Torbay Signs

GA Panel Fix

GA WP1

GA WP2

Independent test results

FP* = 20.5kN.m

FP* = 9.8kN.m

These load results clearly demonstrate the strength of the GA Panel Fix system. The type of fixings used (screws/bolts) and load bearing qualities of the substrate will ultimately determine load performance. Refer to www.goodingalum.com for details. FP* = Failure pressure

GA Pan-L-Trim: Wallboard Profiles

Slim and trim

GA's sleek, stylish and streamlined Pan-L-Trim framing profiles are 'doing the business' in retail multiples and other commercial installations throughout the country. Designed to be seen, these elegant and impact resistant trims are rapidly and 'secretly' fixed and are ideally suited for fast track applications.

Features – Benefits

- Radiused faces – No sharp edges
- Tapering flanges – Secure fixing
- Aluminium alloy – Added durability
- Range of profiles – Different widths accommodated
- Longitudinal grooves – Easy drill bit location
- Cut to size option – Time saving
- Mill from stock – Immediate availability
- Anodising grade – Matt finish option
- Two part corner profile – Fitting made easy

Specification 6063 T5

Available from stock mill finish

When ordering please quote the GA code

Samples will be sent on request

Panel / Wallboard 20mm profiles

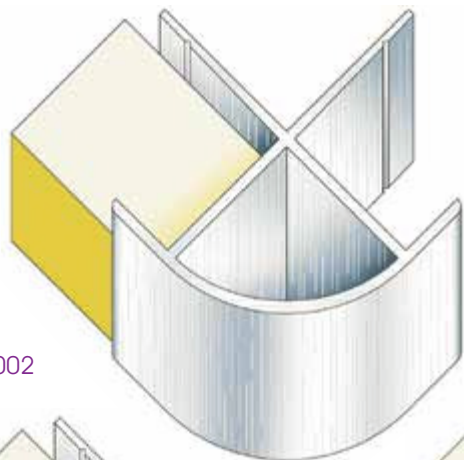

GA PLT2002

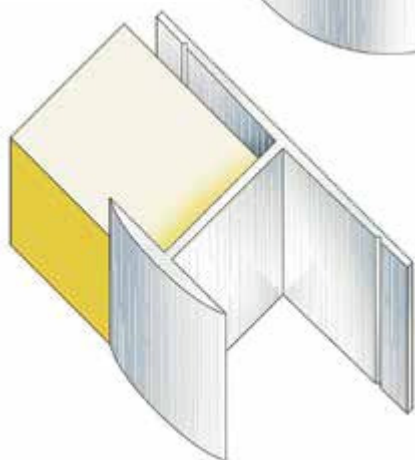

GA PLT2001

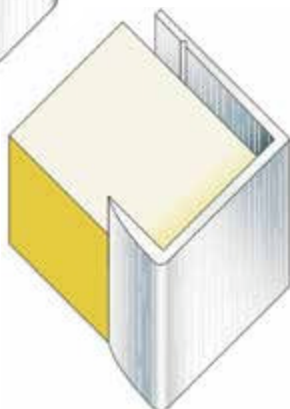

GA PLT2003

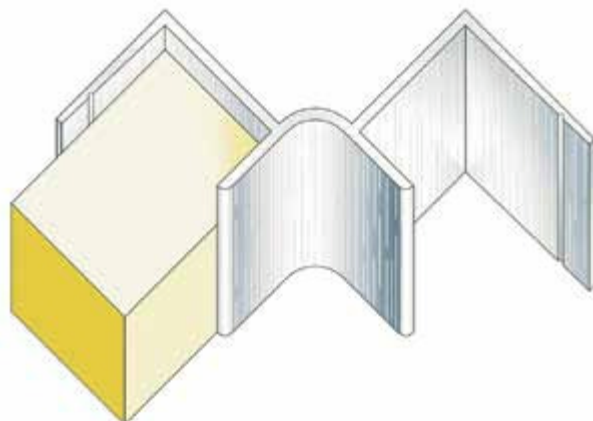

GA PLT2004



Virgin Megastore, Camden: Pan-L-Trim – Anodised

“Wow! What a super range”

Andrew Gisby,
Apton Partitioning

new

Order on-line at www.godingalum.com

Call the GA Helpline and discuss your requirements
Monday-Friday / 8.30am-5.00pm

GA Helpline **020 8692 2255**





Panel / Wallboard 16mm profiles

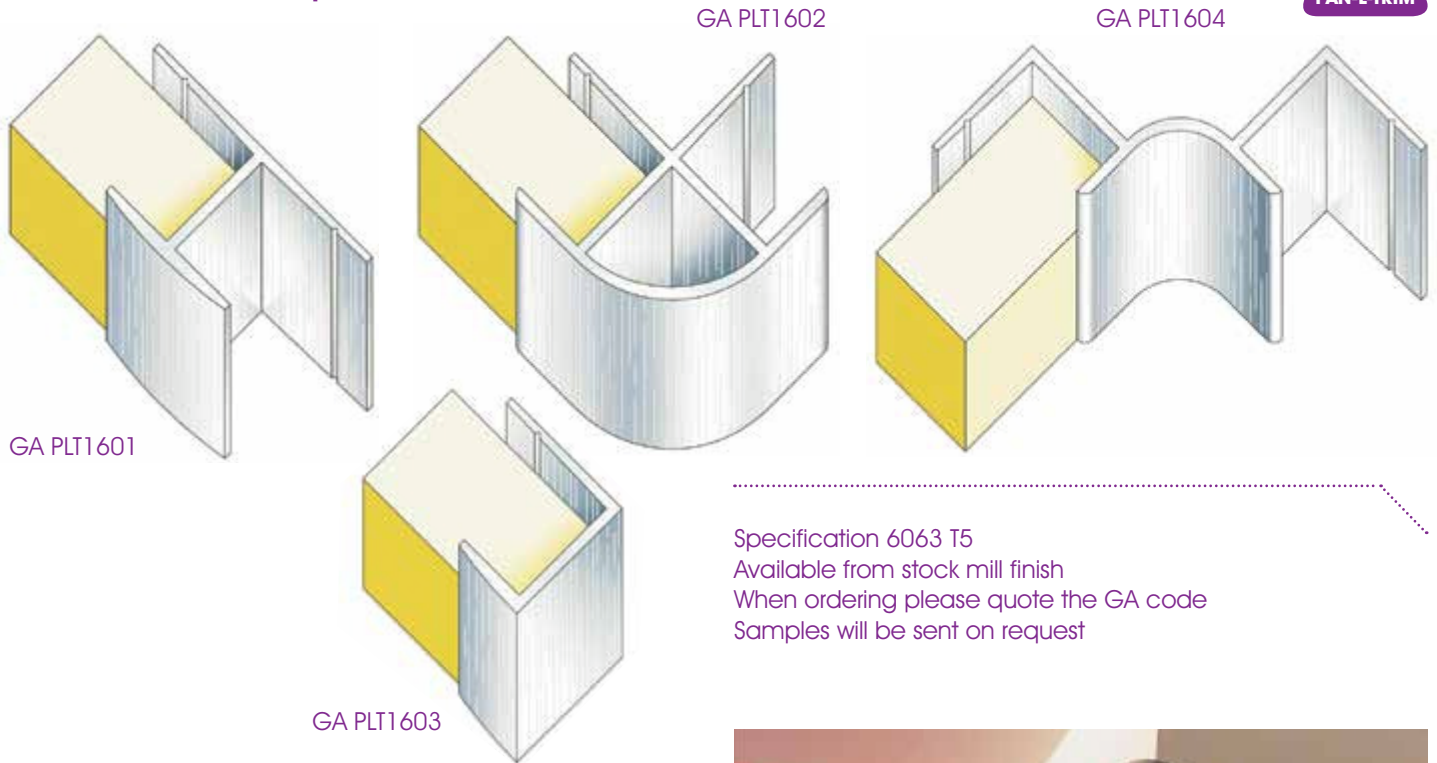

Specification 6063 T5
 Available from stock mill finish
 When ordering please quote the GA code
 Samples will be sent on request

Panel / Wallboard 13mm profiles

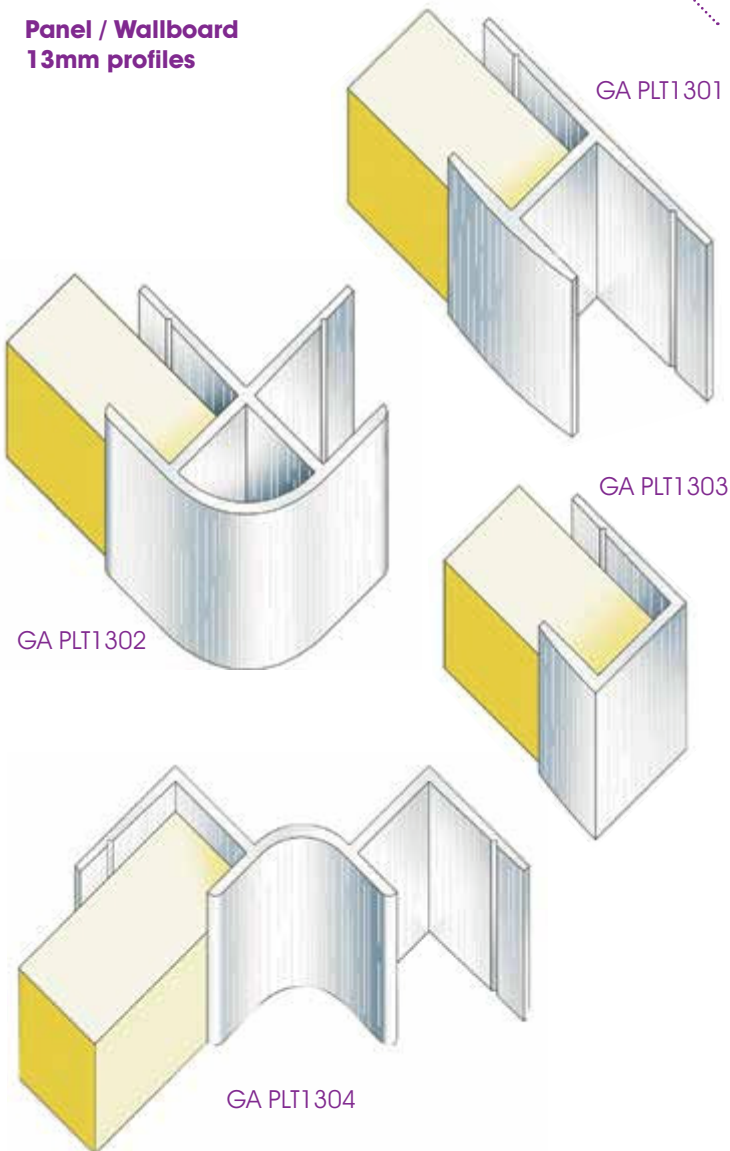

Virgin Megastore: GA PLT 13/16 Ano-Sil Anodised



Panel / Wallboard 6mm profiles

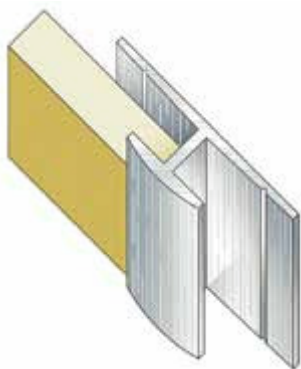

GA PLT601

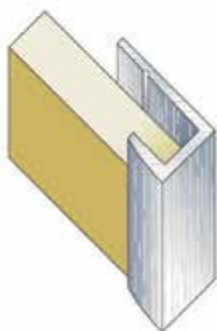

GA PLT603

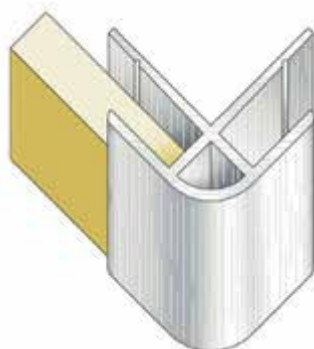

GA PLT602

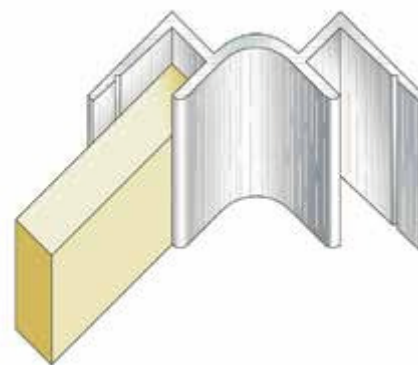

GA PLT604

GA Pan-L-Trim: Wallboard Profiles
Better bi design

Fitting boards (13-16mm) into corner trims is so straight forward with GA's flexible bi-sectional system. Simply push the curved 'female' top profile onto the grooved stem of the fixed 'male' profile when the board is ready for securing. What could be easier?

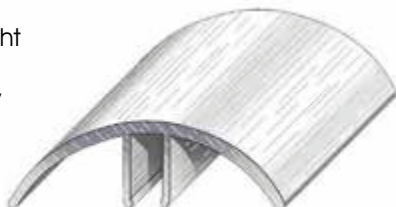

GA PLT13/16



GA Pan-L-Trim: 3mm Board/Panel Profiles

Our aluminium board/panel trims (3mm) are stocked in 4 metre lengths.

You can order these aluminium board/panel trims online today for prompt dispatch.

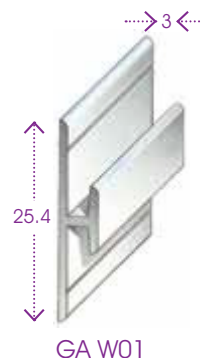

GA W01

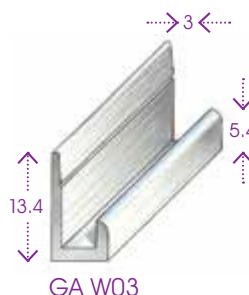

GA W03



GA W02

Specification 6063 T5
Available from stock mill finish
When ordering please quote the GA code
Samples will be sent on request



new

Order online @ www.goodingalum.com

Information Hotline **020 8692 2255**



Pan-L-Trim Elite: Wallboard Profiles

new

Our new 'Elite' range of Pan-L-Trim aluminium wall board extrusions will enhance many paneling installations with their satin smooth and finely ribbed anodised surfaces.

Cleverly designed in a way not to be seen, the reduced dimensions of 'Elite's' board retaining flanges combine with finely fluted satin anodised surfaces, minimising visibility and also any undesirable surface reflections.

The textured alloy surfaces of these good looking extruded profiles also help to disguise any surface markings or scratches that may occur during their service lifespan.

With immediate stock availability and the option of integral shadow gap designs, for 13 and 16mm board thicknesses, the 'Elite' range of Pan-L-Trim aluminium profiles are sure to be an important element of many board and paneling projects.

Features – Benefits

- Ribbed visible surfaces – Resistant to marks and scratches
- Minimal retaining flanges – Unobtrusive
- Shadow gap jointing – Additional design option
- Surface finished – From stock, ready to use
- Satin anodised – High quality finish
- Range of profiles – Suitable for 13 & 16mm boards
- Secret fixing – All fixings hidden by boards/panels
- Grooves in fixing legs – Easy drill bit location
- Cut to size option – Time saving

Panel / Wallboard 13mm profiles

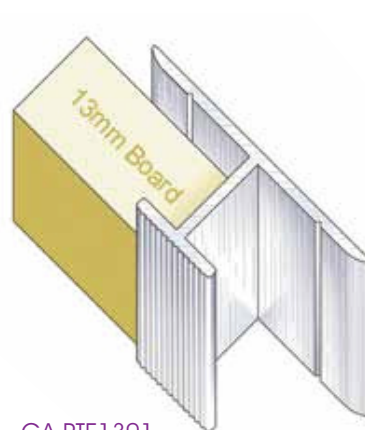

GA PTE1301

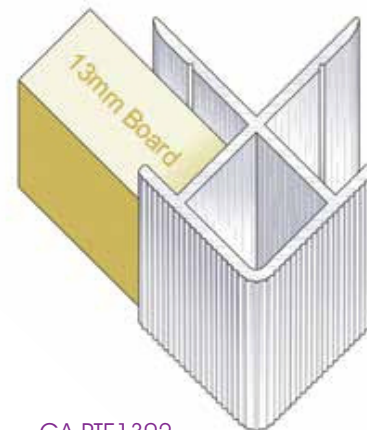

GA PTE1302

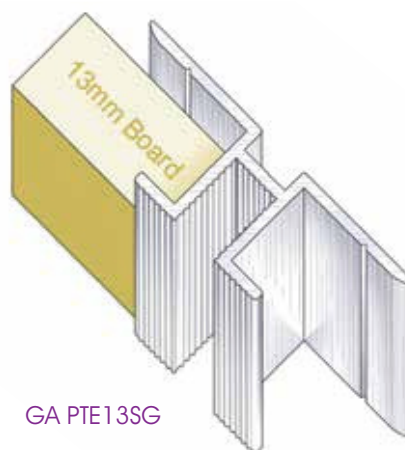

GA PTE13SG

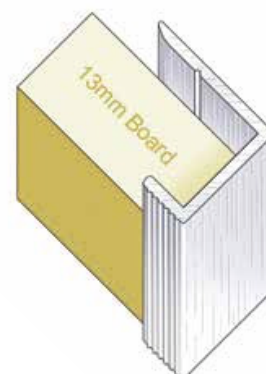

GA PTE1303

Panel / Wallboard 16mm profiles

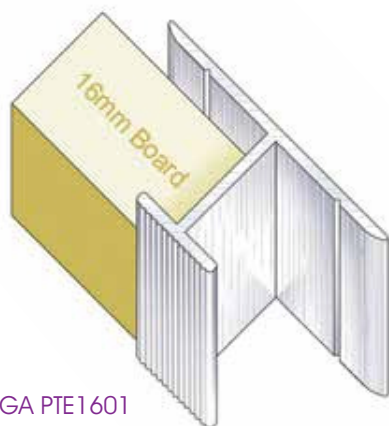

GA PTE1601

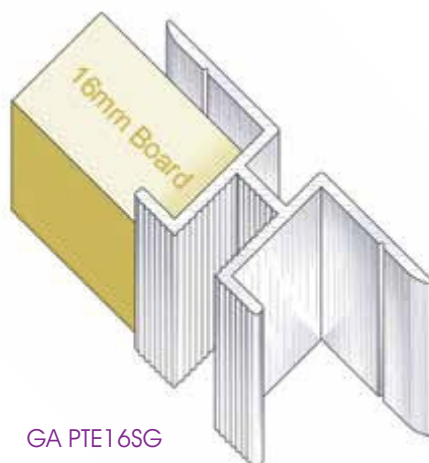

GA PTE16SG

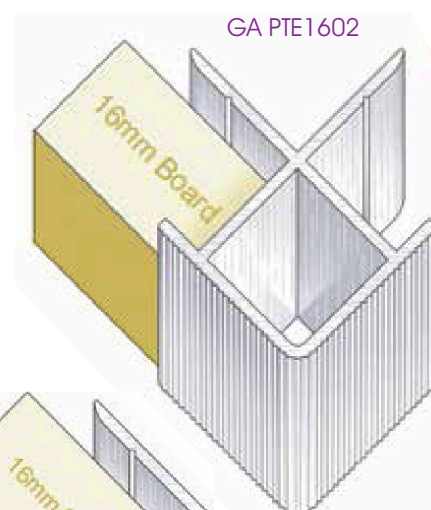

GA PTE1602

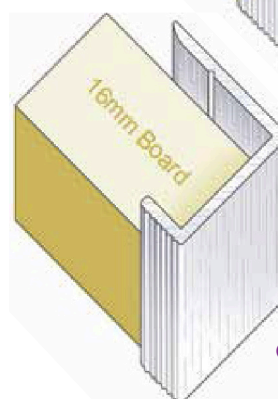

GA PTE1603

Specification 6063 T5
Stocked in natural anodised finish
When ordering please quote the GA code
Samples will be sent on request